

Maven Wireless

The Game changer in wireless coverage

14 Novembre 2019



Maven Wireless - we have done it before !

L'équipe dirigeante Maven Wireless est pionnière depuis les débuts de l'existence de répéteurs et dispose d'une expertise en couverture radio mobile indoor de plus de 20 ans.



A world map with several red location pins and national flags placed over various regions, including Europe, Asia, and the Americas. The flags include Sweden, Estonia, Czech Republic, France, Poland, and Hong Kong.



Vision globale des solutions Maven

Une plateforme de transport digital DAS de nouvelle génération

- Master Node Orion et Remotes Stratus (+43dBm) et Cumulus (+30dBm)
- Réseaux cellulaires, PMR/TETRA (+40dBm) et GSM-R

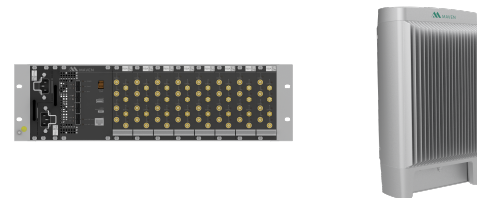

Répéteurs Off Air

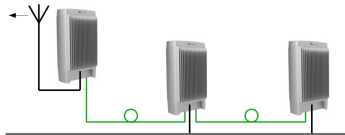

- Cirrus Off Air Master
- Répéteurs RF digitaux Exo (+43dBm) et Strato (+30dBm)
- Tropo (+18dBm)

Répéteur digital embarqués pour les trains et les navires (TOR)

- Jusqu'à 4 bandes en + du GSM-R / multi-opérateurs
- Offre une garantie de débit et de qualité de liaison à bord du train, même dans les zones rurales (+30 dBm sur la liaison montante)



1

Qu'est ce que la 5G ?

Une diversité de nouveaux usages, notamment pour les secteurs verticaux

eMMB

Services large bande évolués
Débit pointe 20Gbps
100 Mbps en bordure
Latence 4ms

10Gbps
1Gbps
100MBps
1 Mbps
100 Kbps
10 Kbps
1 Kbps
1 Kbps

DEBITS

eMTC

Communications massives
de type machine
1M objet / km2



Environnement, Agriculture



360° immersif



10 to 50 Mbps



10 - 100 ms



Capteurs



CCTV

YouTube 8K

50 to 200 Mbps

5G



Ville Intelligente

LATENCE

Cloud gaming

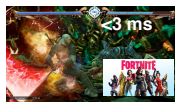

< 3 ms

Réalité Augmentée,
Réalité Virtuelle



< 15 ms

Mobile Trading



Automatisation de
l'industrie 4.0
Latence 10 ms - 1 ms

URLLC

Communications Ultra fiable
et faible latence <1ms



< 5ms

Internet tactile



Véhicule Autonome

Smart Office 5G

- Sécurité Augmentée
- Collaboration Augmentée
- Accès instantané au Cloud (VDI/XaaS)
- Expériences immersives
- Optimisation de la gestion/maintenance des espaces
- Social VR/Gamification

1 s

100 ms

10 ms

1 ms

2

Comment diffuser la 4G 5G à l'intérieur des bureaux HQE ?

5G : Nouvelles fréquences « bande cœur » et « ondes millimétriques »

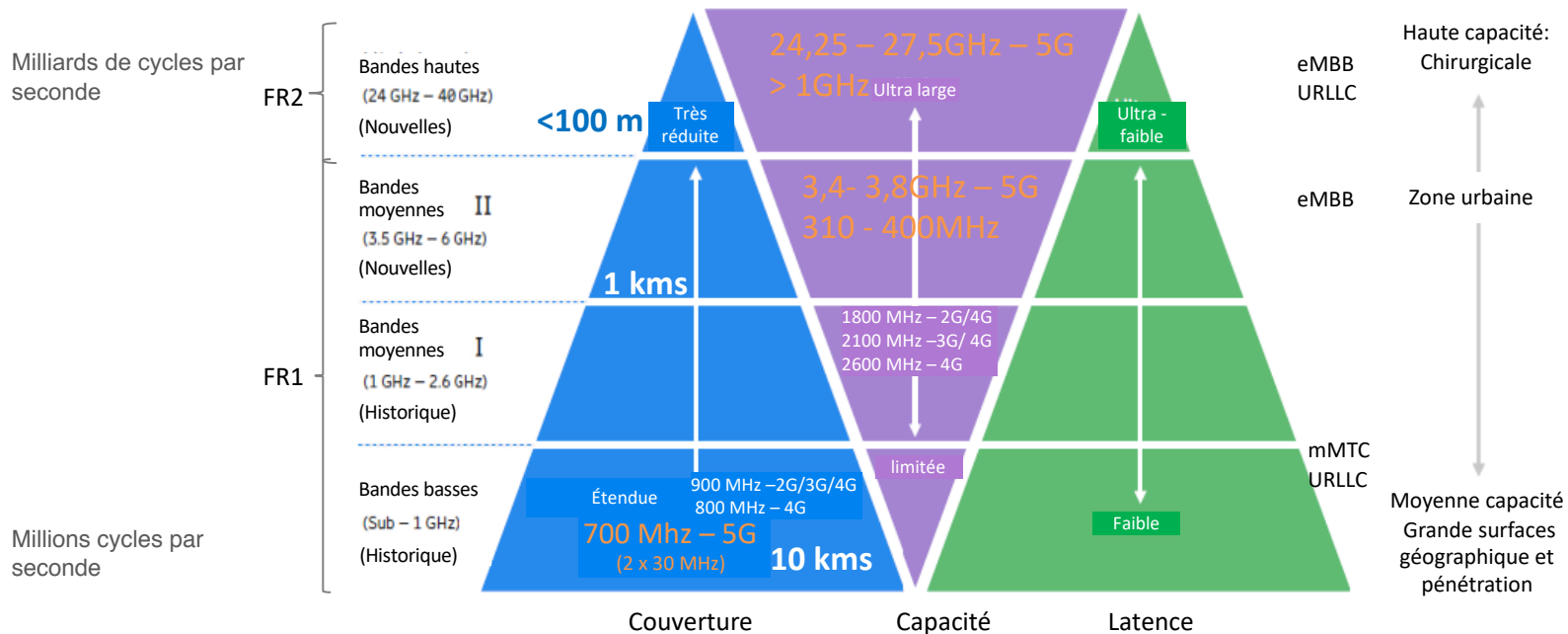

5G indoor : des solutions adaptées aux besoins

Bandes
Opérateurs
Evolutivité

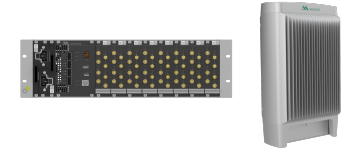
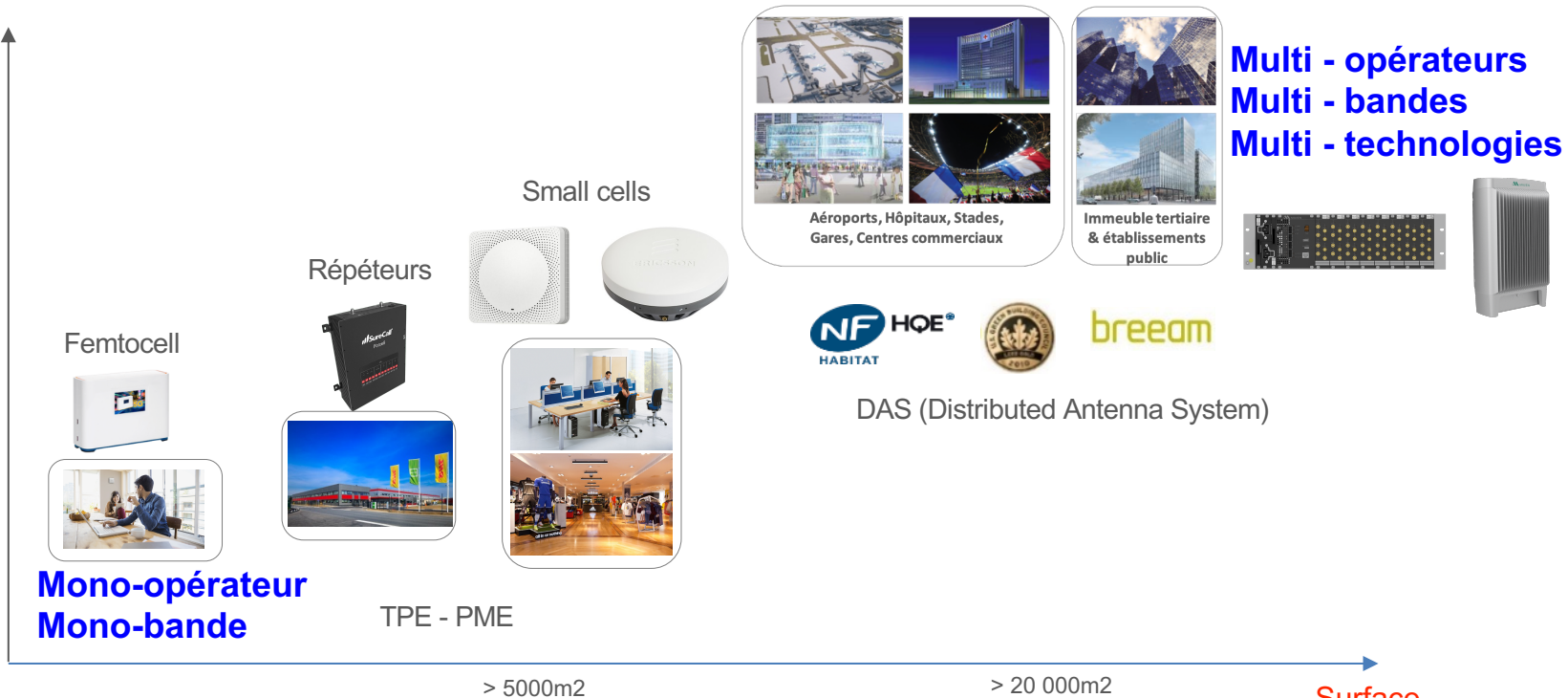

DAS digital d'aujourd'hui

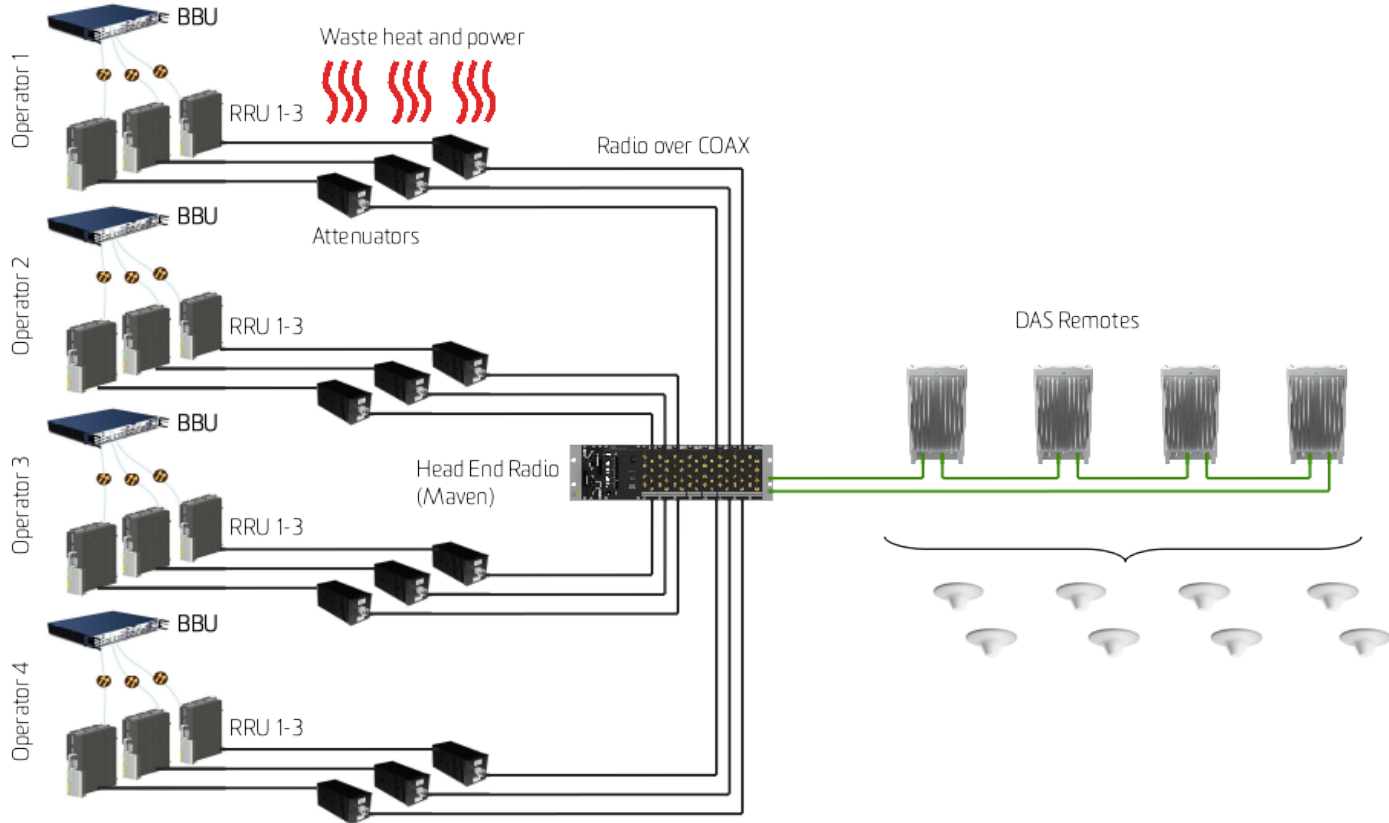

L'évolution du DAS digital : Direct eCPRI

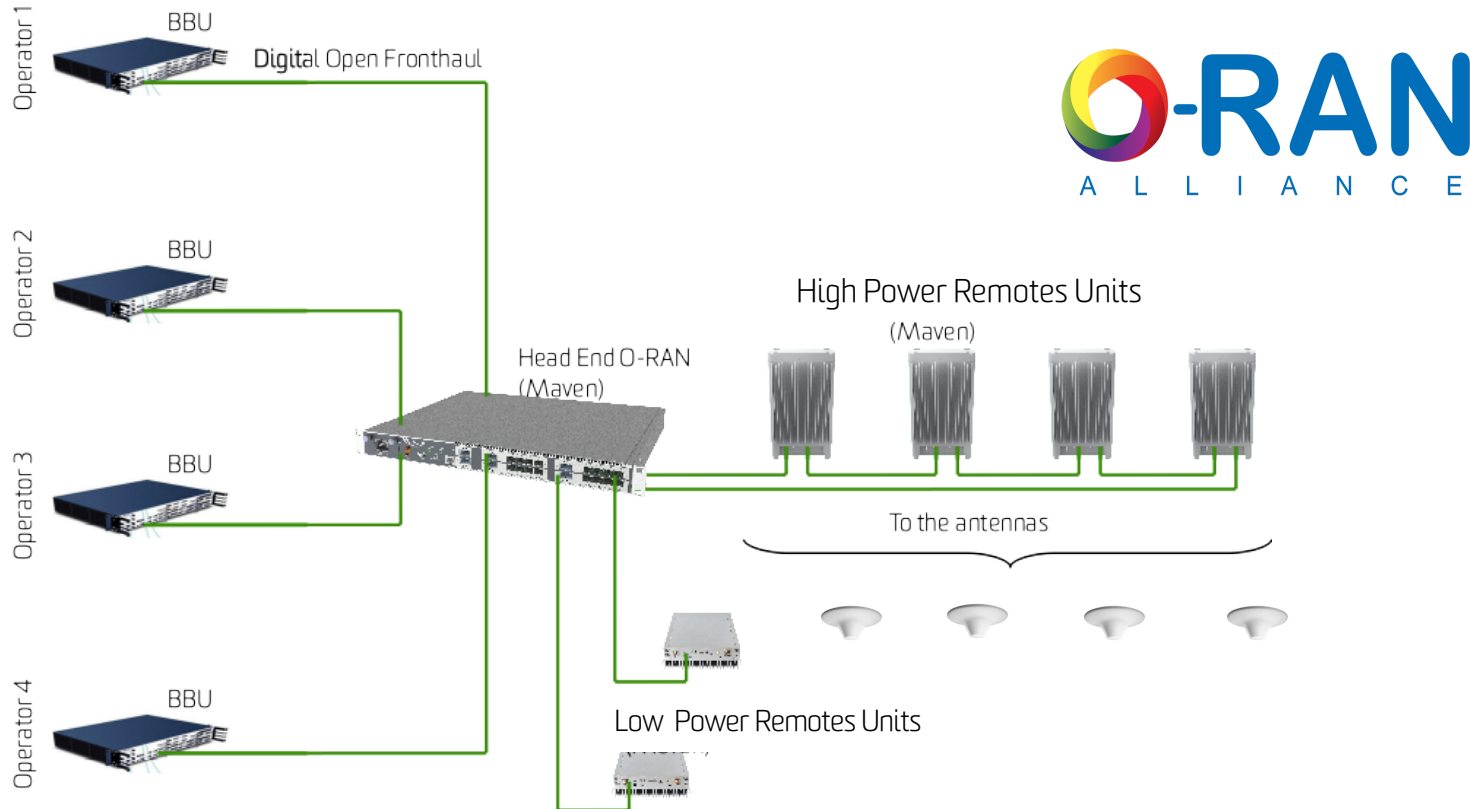

Valeur ajoutée Maven Wireless



Remote Unit
Stratus ou
Cumulus

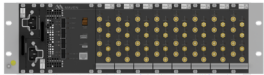

Orion head end
19" unit

- Multi-opérateurs multi-technologies
- DAS Evolutif 4G 5G Ready
- Indépendance des fréquences - technologies
- Réduction consommation d'énergie
- Réduction des coûts d'exploitation

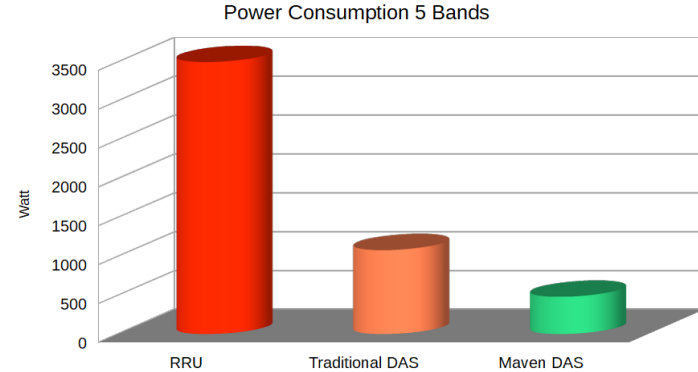

Find out more!

www.mavenwireless.com

info@mavenwireless.com

Follow us on

